

An investigation into the use of aspects of Biomimicry in ship rudder design

Julian Harding MSc BEng

University of Plymouth, UK



[Linkedin.com/in/julianharding](https://www.linkedin.com/in/julianharding)



Julian.harding@babcockinternational.com



UNIVERSITY OF
PLYMOUTH

Background to Research

- UK Shipping
- Manoeuvrability



Rudder Hydrodynamics

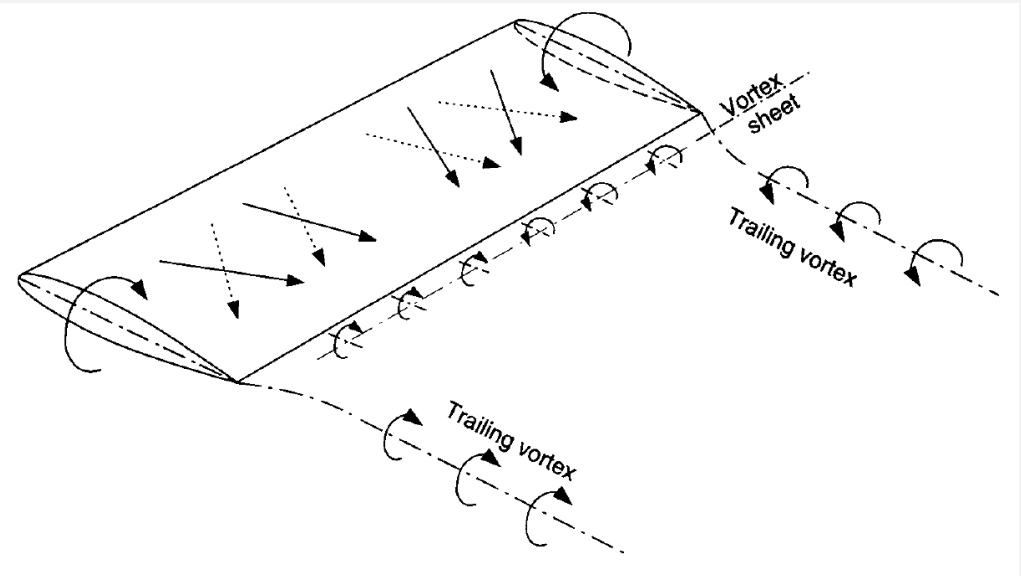
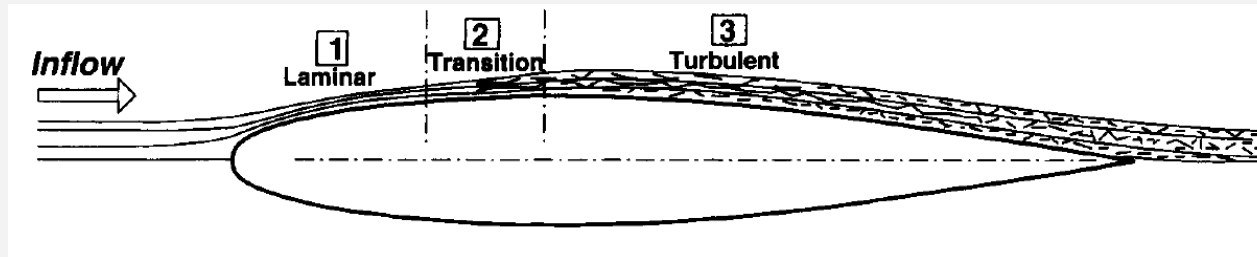

Molland, A. F. & Turnock, S. R., 2007.
Marine Rudders and Control Surfaces.
Oxford: Elsevier.

Existing Rudders

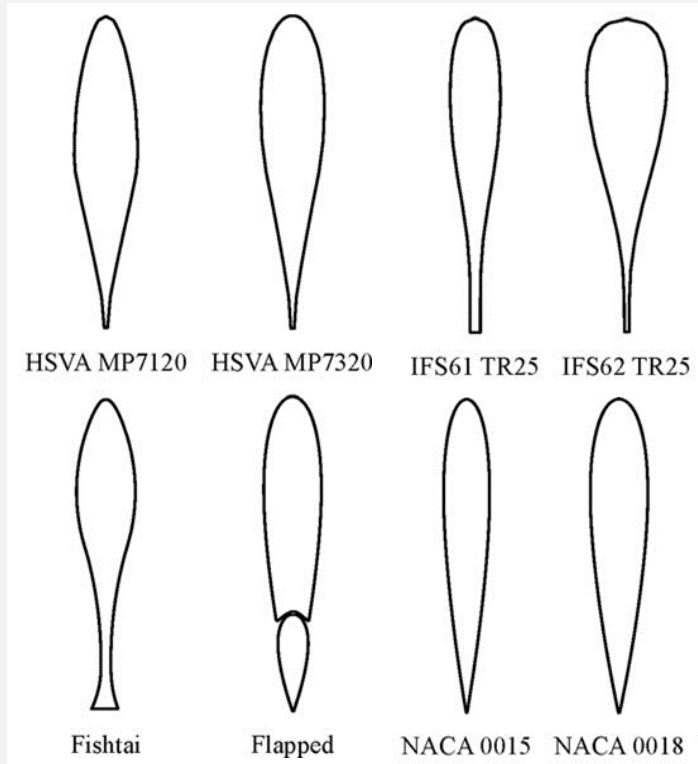

Molland, A. F. & Turnock, S. R., 2007. *Marine Rudders and Control Surfaces*. Oxford: Elsevier.



[Linkedin.com/in/julianharding](https://www.linkedin.com/in/julianharding)



Julian.harding@babcockinternational.com



UNIVERSITY OF
PLYMOUTH

What is Biomimicry?

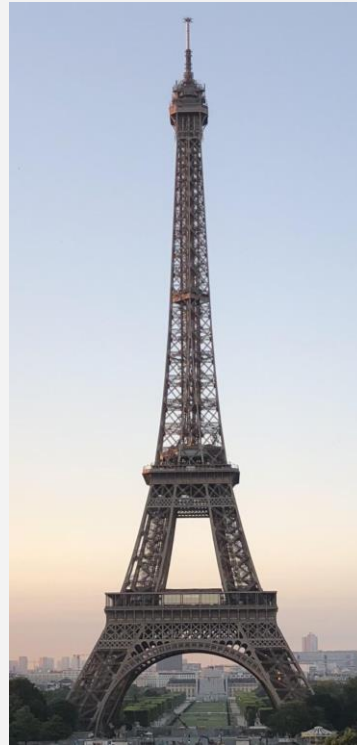
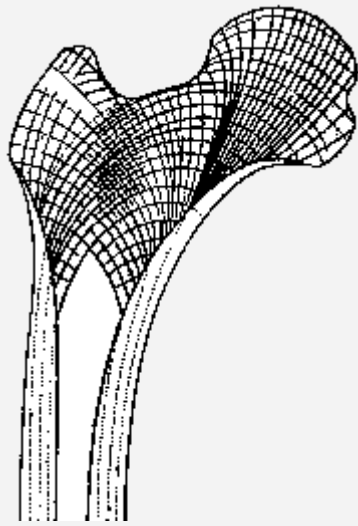

Bio-inspiration

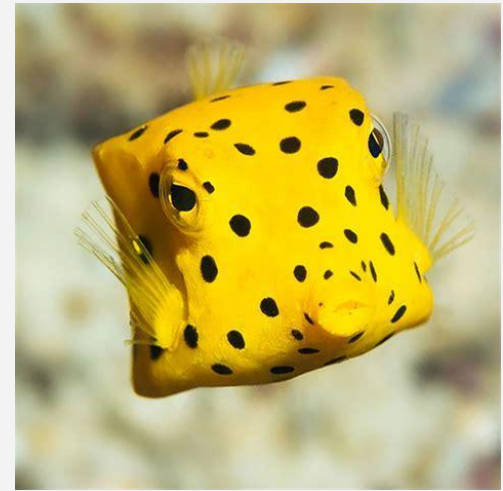

[Linkedin.com/in/julianharding](https://www.linkedin.com/in/julianharding)



Julian.harding@babcockinternational.com



UNIVERSITY OF
PLYMOUTH

Design

- Selection of features
- Modelling and Build



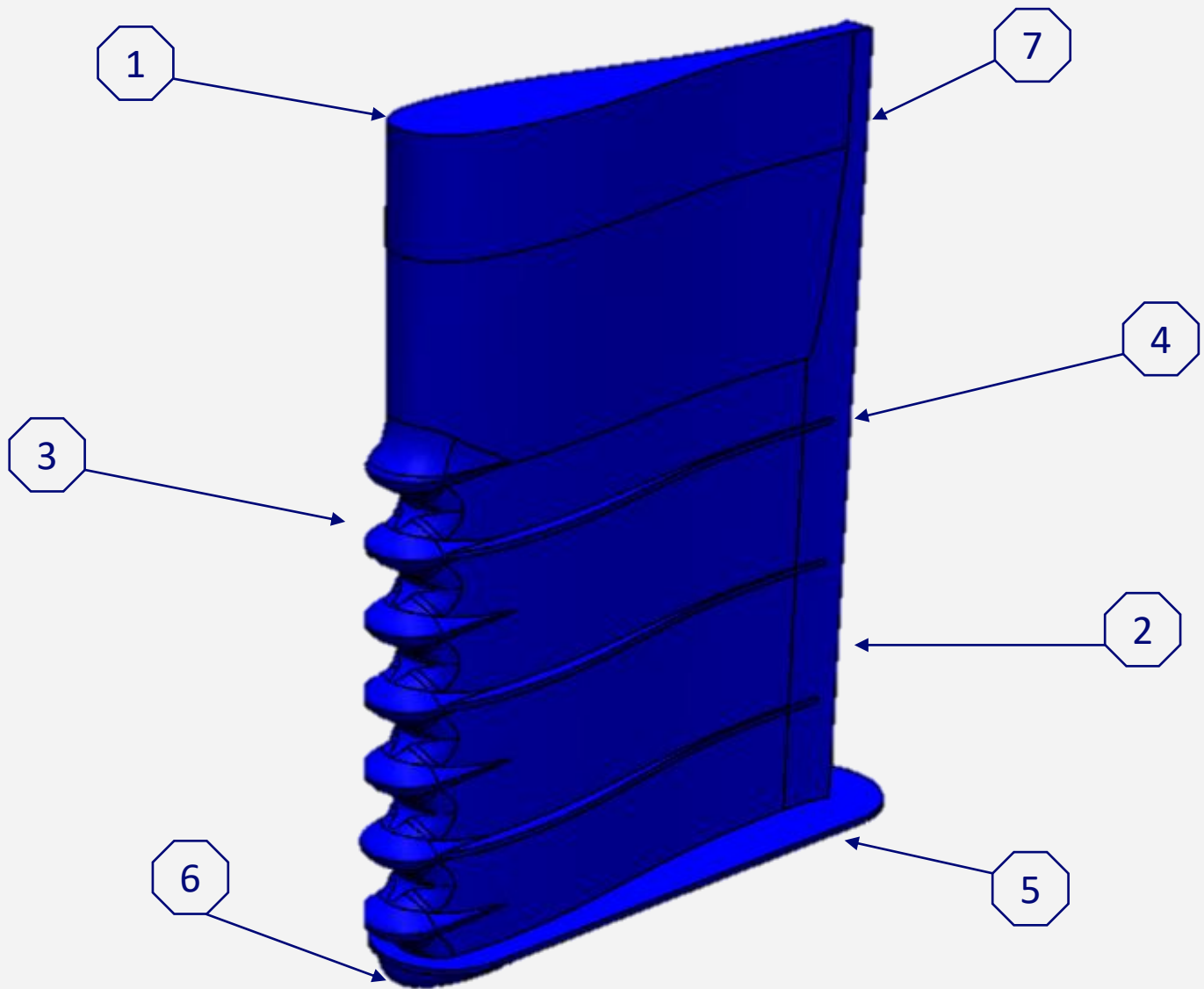

[Linkedin.com/in/julianharding](https://www.linkedin.com/in/julianharding)



Julian.harding@babcockinternational.com



UNIVERSITY OF
PLYMOUTH

Experimental Procedure

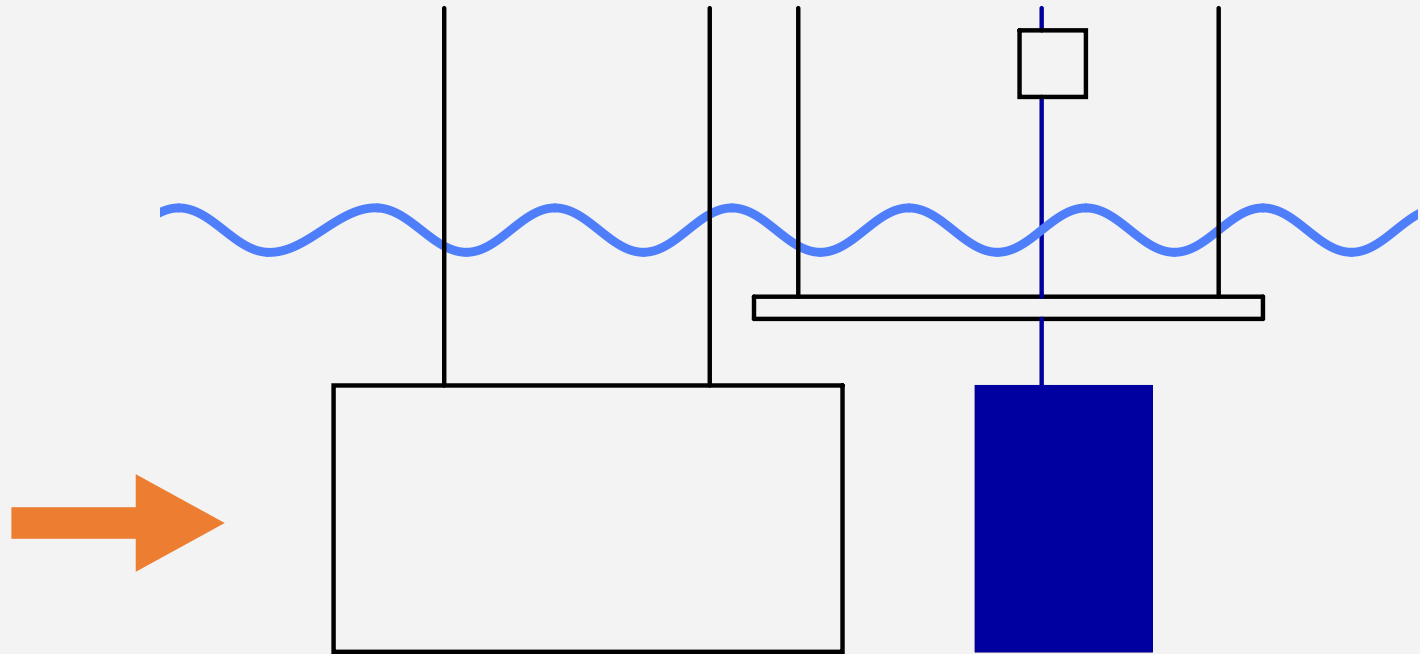

Results

- Lift and Drag
- Vortex Control



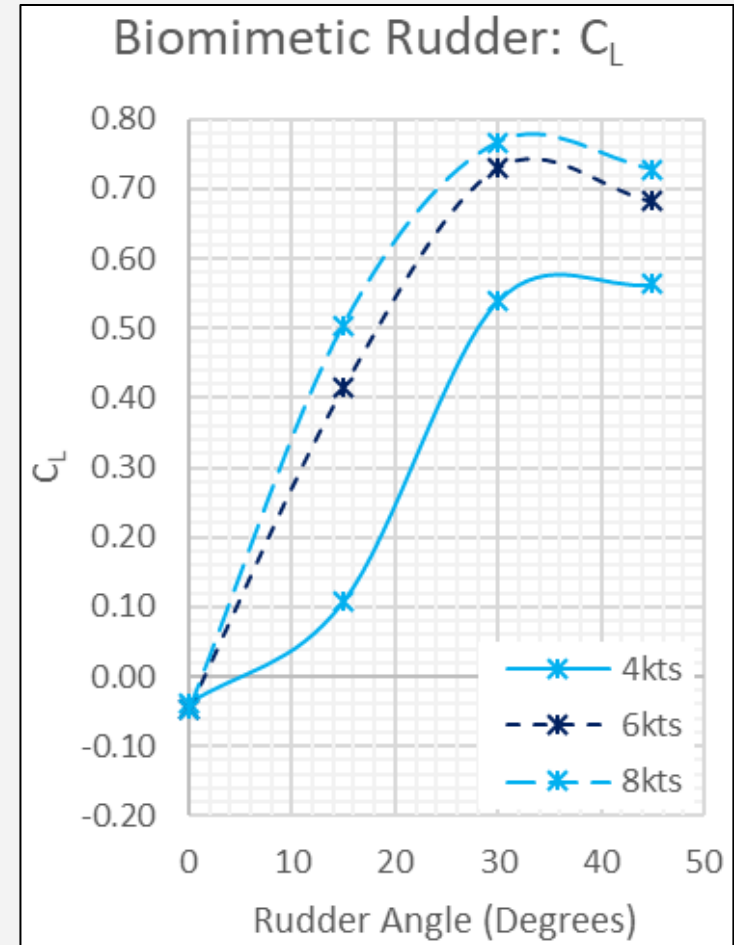
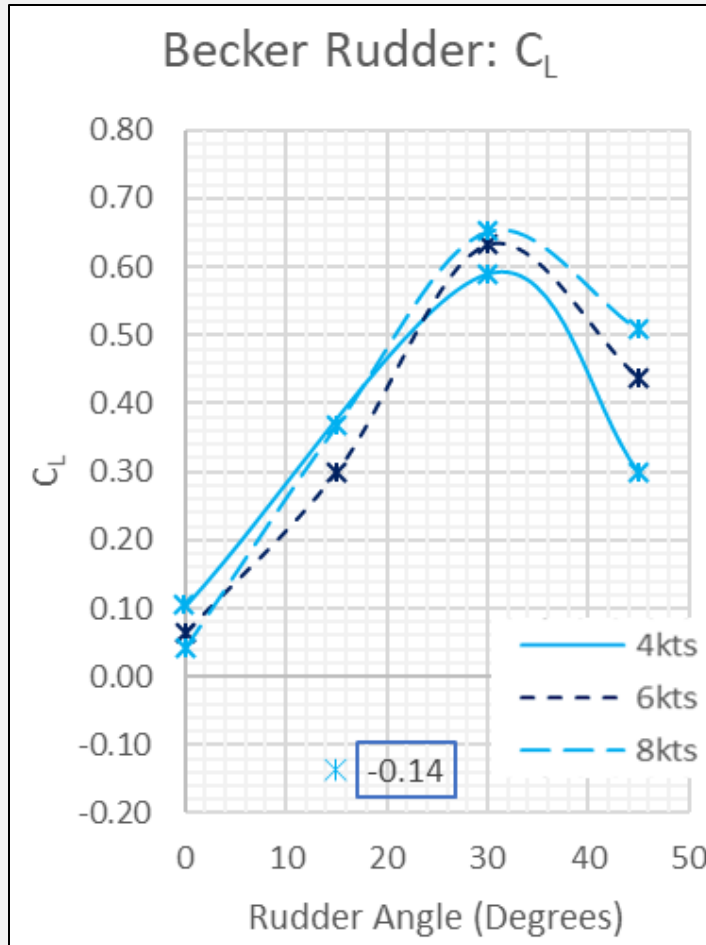

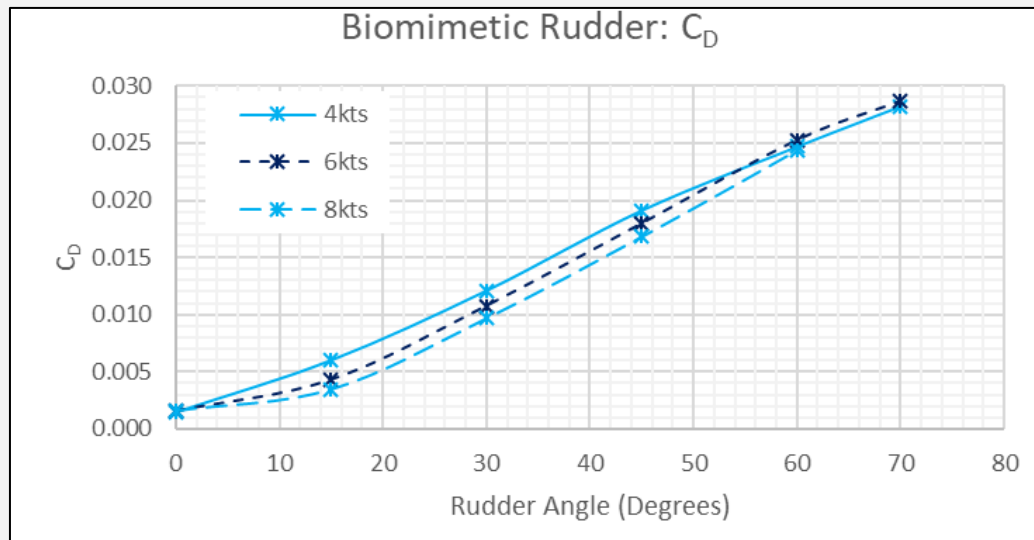
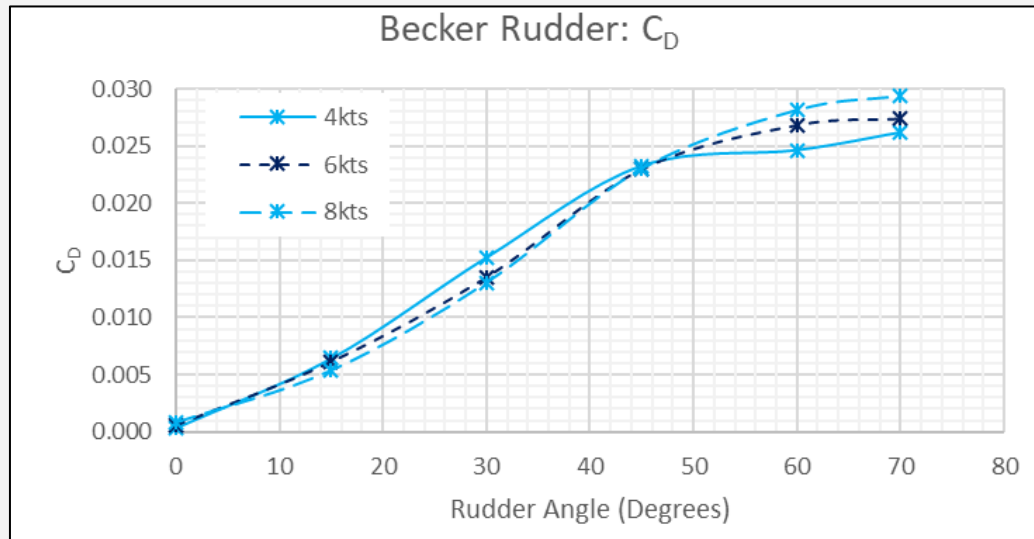

Visual Observations

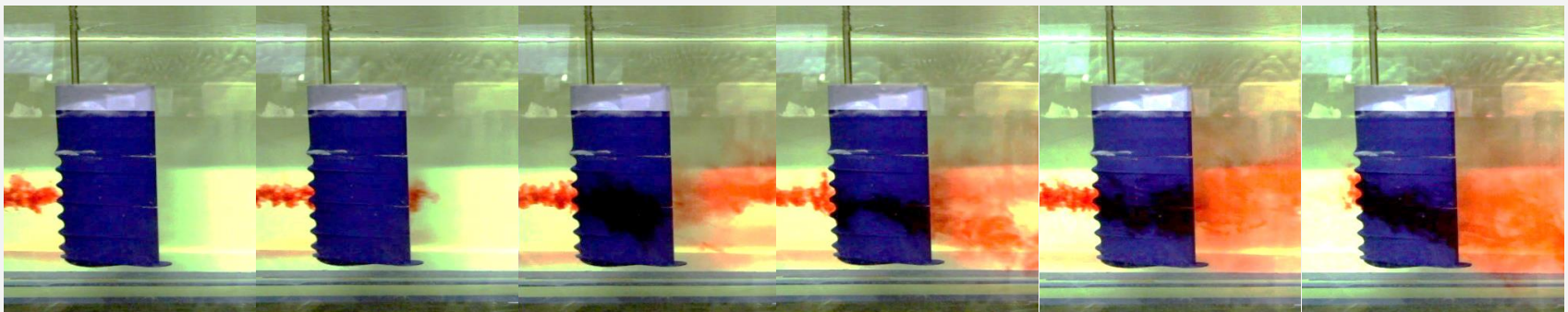
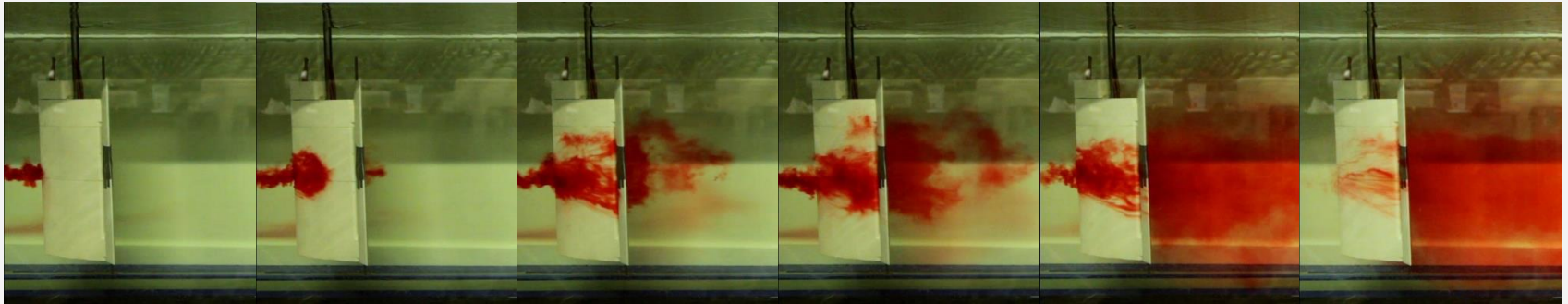

Conclusions



[Linkedin.com/in/julianharding](https://www.linkedin.com/in/julianharding)



Julian.harding@babcockinternational.com



UNIVERSITY OF
PLYMOUTH

Future Development



[Linkedin.com/in/julianharding](https://www.linkedin.com/in/julianharding)



Julian.harding@babcockinternational.com



UNIVERSITY OF
PLYMOUTH

Thank you



UNIVERSITY OF
PLYMOUTH



Biomimicry Institute; www.biomimicry.org



[Linkedin.com/in/julianharding](https://www.linkedin.com/in/julianharding)



Julian.harding@babcockinternational.com



[Linkedin.com/in/julianharding](https://www.linkedin.com/in/julianharding)



Julian.harding@babcockinternational.com



UNIVERSITY OF
PLYMOUTH